

## DATA SHEET: TEMBREAK 2 S800-NE MCCB

MCCB Electrical Characteristics to IEC 60947-2, EN 60947-2, JIS C 8201-2-1 ANN. 1, AS/NZS 3947-2, NEMA AB-1

Frame reference	Quantity	Unit	Condition	TB2 1000
Max In (A) of Frame				<b>800</b>
Model				S800
Number of Poles				3, 4
Type				NE
<b>Nominal current ratings</b>				
	$I_n$	(A)	50°C	630 800
<b>Electrical characteristics</b>				
Rated operational voltage	$U_e$	(V)	AC 50/60 Hz DC	690 -
Rated insulation voltage	$U_i$	(V)		800
Rated impulse withstand voltage	$U_{imp}$	(kV)		8
Ultimate breaking capacity (IEC, JIS, AS/NZS)	$I_{cu}$	(kA)	690V AC	20 <sup>①</sup>
			525V AC	30
			440V AC	50
			400/415V AC	50
			220/240V AC	85
			250V DC	-
Service breaking capacity (IEC, JIS, AS/NZS)	$I_{cs}$	(kA)	690V AC	20 <sup>①</sup>
			525V AC	30
			440V AC	50
			400/415V AC	50
			220/240V AC	85
			250V DC	-
Rated breaking capacity (NEMA)		(kA)	480V AC 240V AC	30 85
Rated short-time withstand current	$I_{cw}$	(kA)	0.3 Seconds	10
<b>Protection</b>				
Adjustable thermal, adjustable magnetic				■
Fixed thermal, fixed magnetic				■
Microprocessor				●
Utilisation category				B
<b>Installation</b>				
Front connection (FC)				■
Extension bar (FB)				●
Cable clamp (FW)				● <sup>②</sup>
Rear connection (RC)				●
Plug-in (PM)				●
DIN rail mounting (DA)				-
Dimensions	height	(mm)		273
	width	(mm)	3 pole 4 pole	210 280
	depth	(mm)		103
	weight	(kg)	3 pole 4 pole	③ ④
Weight				
<b>Operation</b>				
Direct Opening Action				■
Toggle operation				■
Door mounted (HS) / Breaker mounted handle (HB)				●
Motor operation (MC)				●
Endurance	Electrical		690V AC	4,000
	Mechanical	cycles cycles		10,000

① MCCB cannot be used in IT systems at this voltage

② 630A only

③ 8.7kg 630A, 9.1kg 800A

④ 11.9kg 630A, 12.3kg 800A

■ Standard    ● Optional    - Not Available



# DATA SHEET: TEMBREAK 2 S800-NE MCCB

## Outline Dimensions S800-NE Plug in Version

ASL: Arrangement Standard Line Ht: Handle Frame Centre Line

### Outline Dimensions

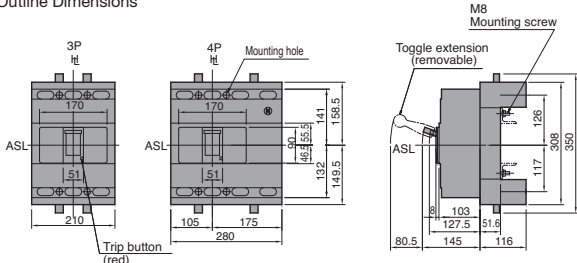

### Termination of Busbar

#### Preparation of conductor

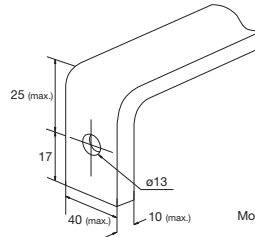

Mounting screw M12x25 max. Hex. sec. head bolt.

### Mounting on a support or rails

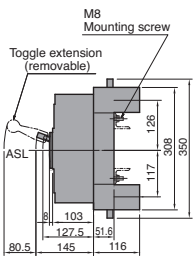

#### Mounting base (rear view)

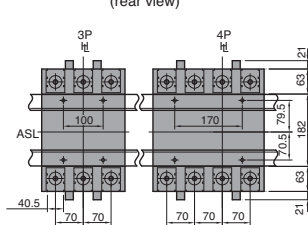

#### Drilling plan (front view)

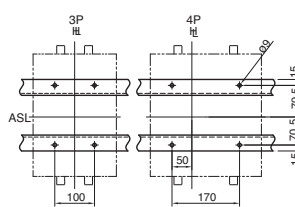

#### Detail of connecting part Oriented for rear access

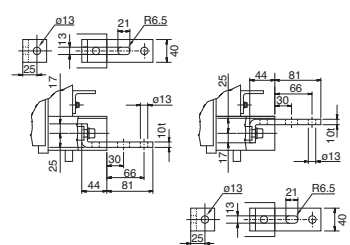

Terminal bars should be connected alternately on adjacent poles.

### Mounting through the backplate (shown with optional connection bars oriented for rear access)

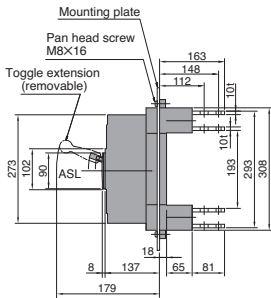

#### (rear view)

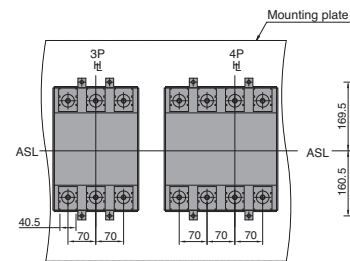

#### Drilling plan (front view)

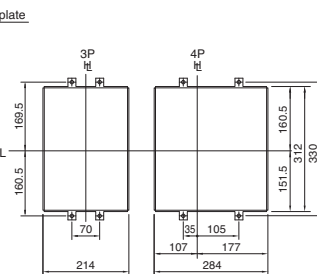

#### Detail of connecting part Oriented for rear access

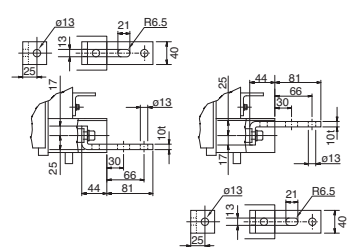

Terminal bars should be connected alternately on adjacent poles.

### Mounting on the backplate (optional connection bars must be oriented for front access)

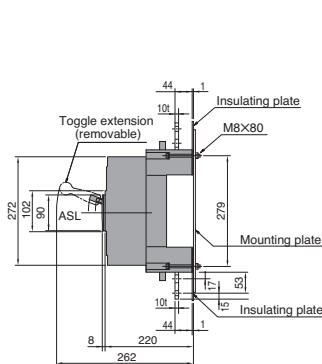

#### (rear view)

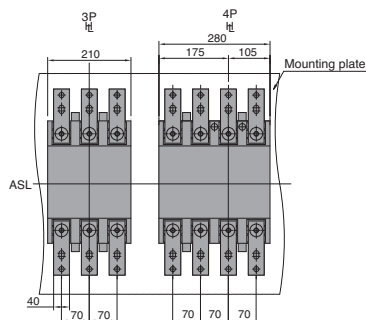

#### Drilling plan (front view)

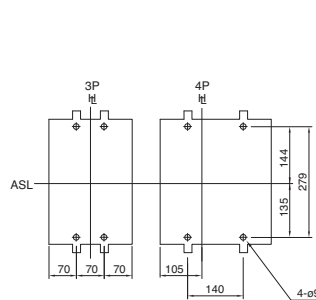

#### Detail of connecting part Oriented for front access

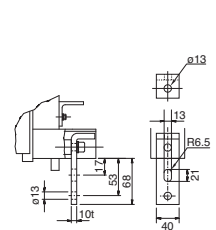

# DATA SHEET: TEMBREAK 2 S800-NE MCCB

## Time/Current Characteristic Curves

S800-NE

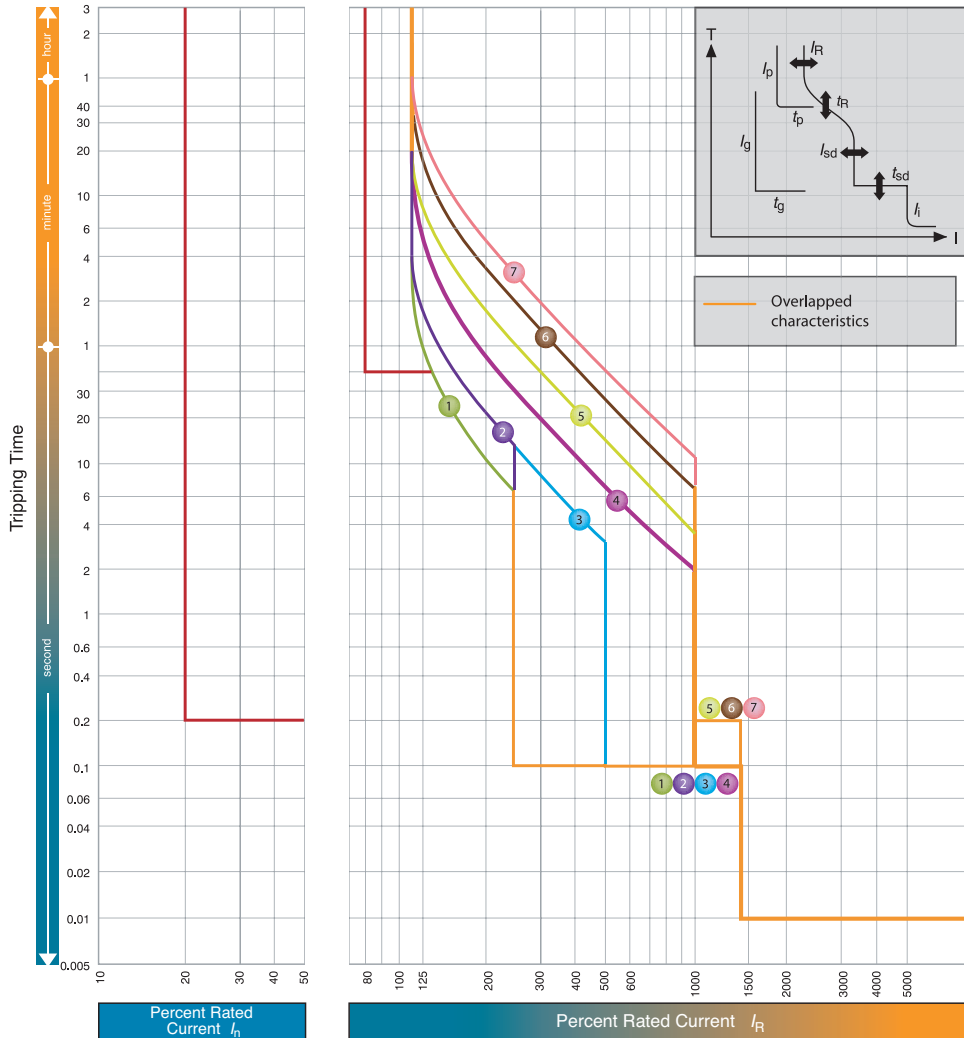

$I_n = 800A; 630A$

		$I_R$ (A)									
		LTD Pick-up current	$I_R$	$x/I_n$	0.4	0.5	0.63	0.8	0.9	0.95	1.0
Standard	LT	$t_R$	(s)		11	21	21	5	10	19	29
	ST	$I_{sd}$	$x/I_R$		2.5			5			
		$t_{sd}$	(s)		0.1				10		
	INST	$I_i$	$x/I_n$		14(Max: $12 \times I_n$ ) Note (1)						
Option	PTA	$I_p$	$x/I_R$		0.8						
		$t_p$	(s)		40						
	GF Note(3)	$I_g$	$x/I_n$		0.2						
		$t_g$	(s)		0.2						
	NP	$I_N$	$x/I_R$		1.0/0.5 Note(2)						
	$t_N$	(s)		$t_N = t_R$							

**Note**

(1)  $I_i$  max. =  $12 \times I_n$ . (2)  $1.0 \times I_R$  or  $0.5 \times I_R$  can be selected. Characteristic of neutral protection ( $t_N$  vs.  $I_N$ ) is identical to characteristic of phase protection ( $t_R$  vs.  $I_R$ ). (3) When you specify GF on MCCBs with 3 poles the terminal block is automatically fitted to connect with the external neutral CT for 3 phases 4 wires system. See terminal blocks in section 4.